

**GEEKOM Mini PC**



# GEEKOM

## A Series

A6 MAX  
A7 MAX  
A8 MAX



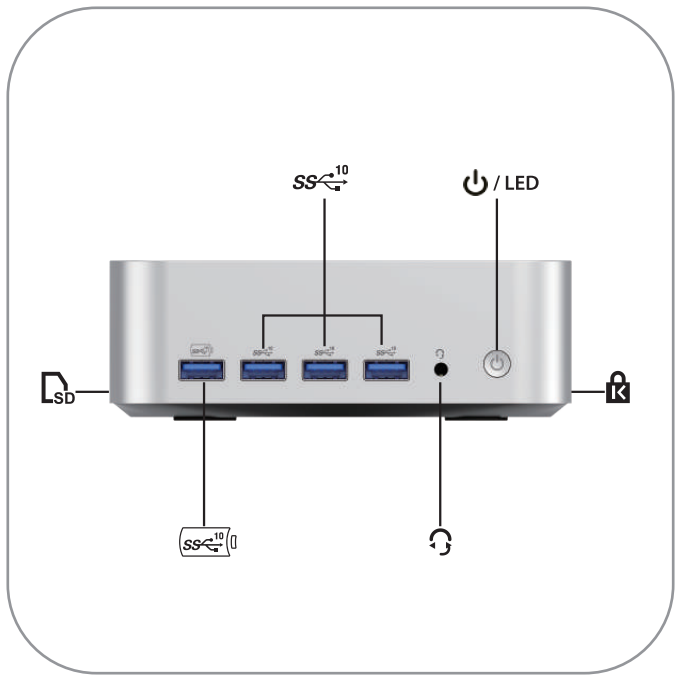

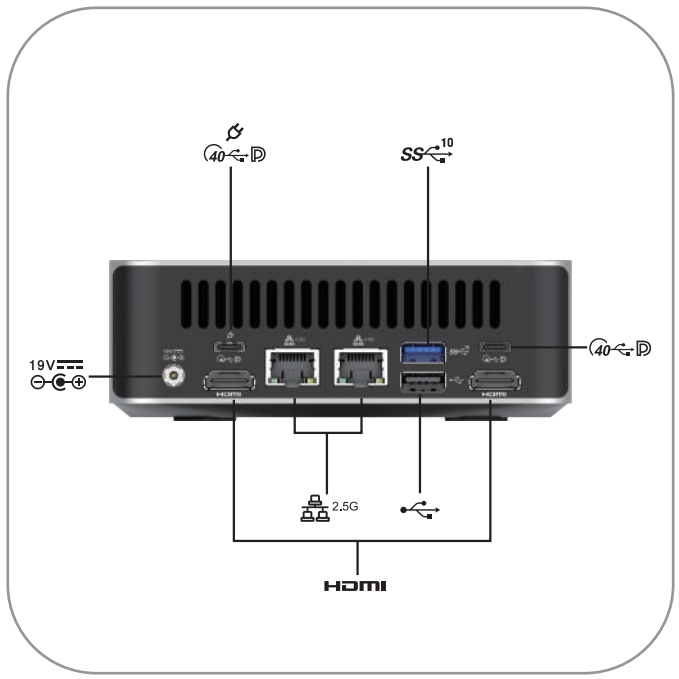



USB 3.2 Gen2 Port  
 USB 3.2 Gen2-Port  
 USB 3.2 Gen2-port  
 USB 3.2 Gen2-poort  
 Puerto USB 3.2 Gen2  
 Port USB 3.2 Gen2  
 Porta USB 3.2 Gen2  
 Порт USB 3.2 2 пок  
 USB 3.2ポート  
 USB 3.2 Gen2 포트  
 USB 3.2 Gen2 端口



Speaker/Headset  
 Lautsprecher/Headset  
 Högtalare/Headset  
 Luidspreker/Headset  
 Altavoces / Auriculares  
 Haut-parleurs/Casque-micro  
 Altoparlante/Cuffia  
 Динамик/гарнитура  
 スピーカー／ヘッドフォン  
 스피커/이어폰  
 扬声器/耳机



Power Button/LED  
 Netztaete/LED  
 Strömknapp/LED  
 Aan/uitknop/LED  
 Botón / LED de Encendido  
 Bouton d'Alimentation/LED  
 Pulsante di Alimentazione/LED  
 Кнопка питания/светодиод  
 電源ボタン／LED  
 전원 버튼/LED  
 电源按钮/LED



USB 3.2 Gen2  
 USB 3.2 Gen2  
 USB 3.2 Gen2  
 USB 3.2 Gen2  
 Puerto USB 3.2 Gen2  
 Port USB 3.2 Gen2  
 Porta USB 3.2 Gen2  
 Порт USB 3.2 2 пок  
 USB 3.2 Gen2  
 USB 3.2 Gen2  
 USB 3.2 Gen2



Ethernet Port  
 Ethernet-Port  
 Ethernet Port  
 Ethernet-poort  
 Puerto Ethernet  
 Port Ethernet  
 Porta Ethernet  
 Порт Ethernet  
 イーサネットポート  
 이더넷 포트  
 以太网端口



19V  
 Electric Power Inlet  
 Stromeingang  
 Elektriskt anslutning in  
 Voedingsaansluiting  
 Entrada de Alimentación Eléctrica  
 Entrée d'Alimentation Vlectrique  
 Ingresso di Alimentazione  
 Вход для электропитания  
 電源コンセント  
 전원 포트  
 电源插口



USB4+DP Port  
 USB4+DP-Port  
 USB4+DP-Port  
 USB4+DP-poort  
 Puerto USB4+DP  
 Port USB4+DP  
 Porta USB4+DP  
 Порт USB4+DP  
 USB4+DPポート  
 USB 4+ DP端口  
 USB 4+ DP포트



HDMI Port  
 HDMI-Port  
 HDMI-Port  
 HDMI-poort  
 Puerto HDMI  
 Port HDMI  
 Porta HDMI  
 Порт HDMI  
 HDMIポート  
 HDMI端口  
 HDMI포트



USB 2.0 Port  
 USB 2.0-Port  
 USB 2.0-port  
 USB 2.0-poort  
 Puerto USB 2.0  
 Port USB 2.0  
 Porta USB 2.0  
 Порт USB 2.0  
 USB 2.0ポート  
 USB 2.0 端口  
 USB 2.0 포트



USB4+DP+PD Input  
 USB4+DP+PD Input  
 USB4+DP+PD Input  
 USB4+DP+PD-Eingang  
 Entrada USB4+DP+PD  
 Entrée USB4+DP+PD  
 Ingresso USB4+DP+PD  
 USB4+DP+PD вход  
 USB4+DP+PD入力  
 USB4+DP+PD 입력  
 USB4+DP+PD輸入



SD Reader  
 SD-Lesegerät  
 SD-läsare  
 SD-lezer  
 Lector SD  
 Lecteur de Carte SD  
 Lettore SD  
 Считыватель SD  
 SD読み取り  
 SD卡读卡器



Anti-Theft Key Lock Hole  
 Diebstahlsicherung-Verriegelungsöffnung  
 Anti-Stöld nyckel låshål  
 Opening voor anti-diefstal slot  
 Orificio de Bloqueo de Llave Antirrobo  
 Orifice pour Verrou Antivol  
 Foro per Chiave/Lucchetto Antifurto  
 Противоугонное отверстие для блокировки  
 盗難防止キーロック穴  
 防盗锁孔

1

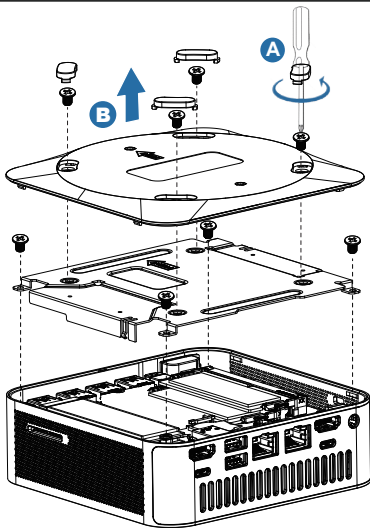

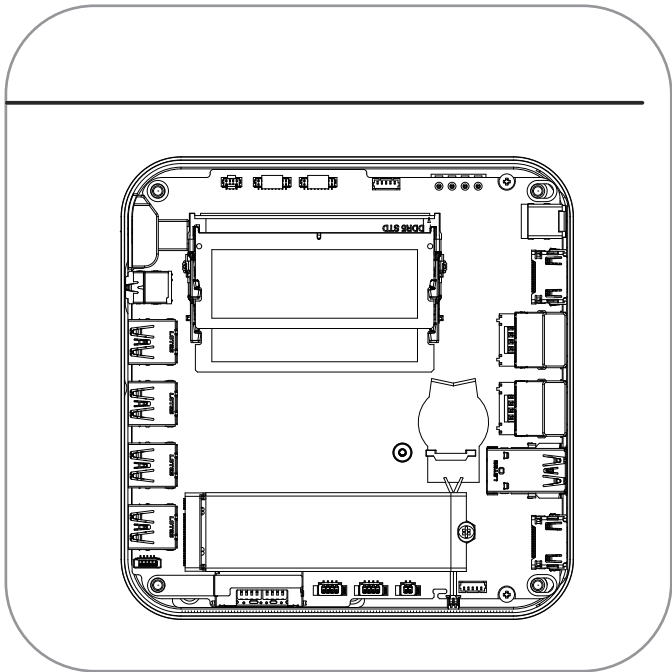

## 2 M.2 SSD

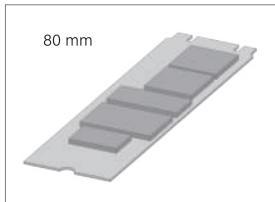
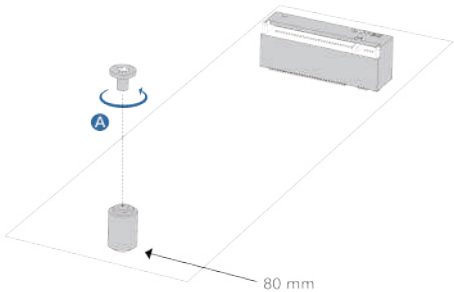

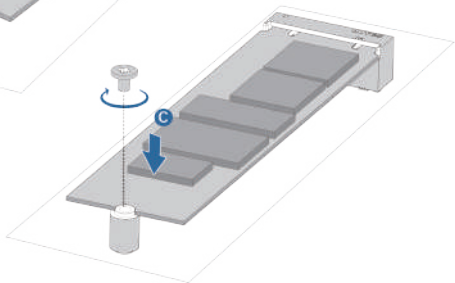
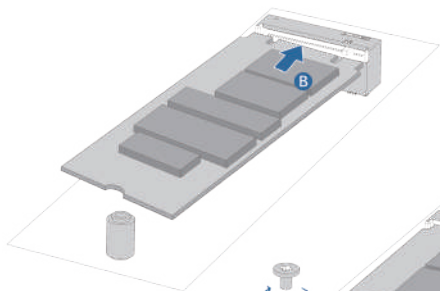

### 3 1.1 V DDR5

---

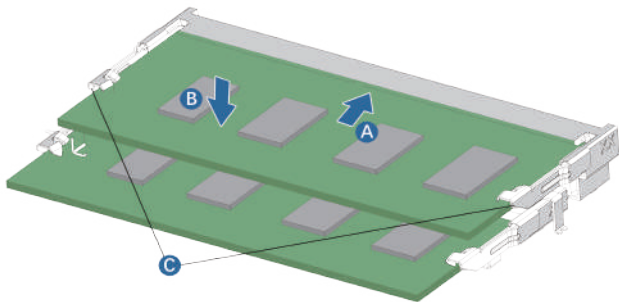

The final product shall prevail

4

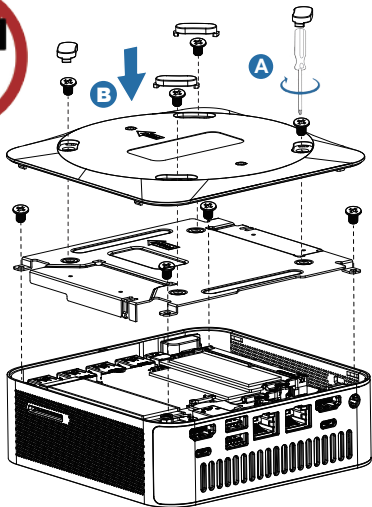

5

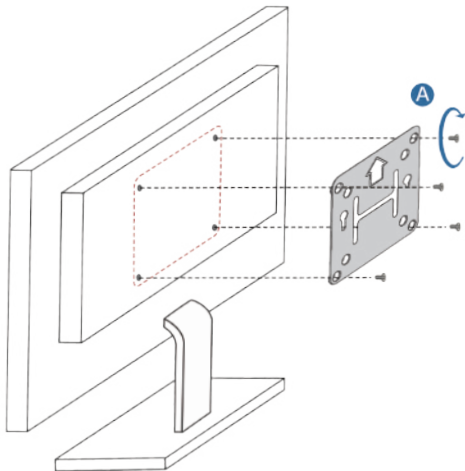

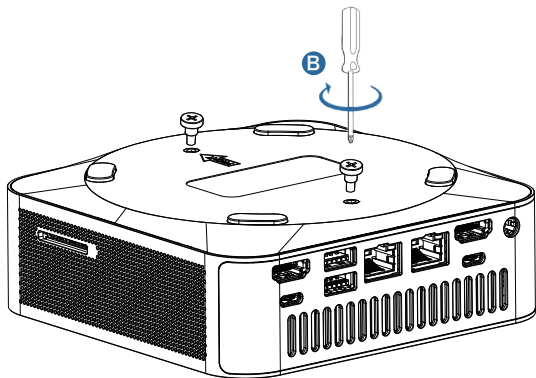

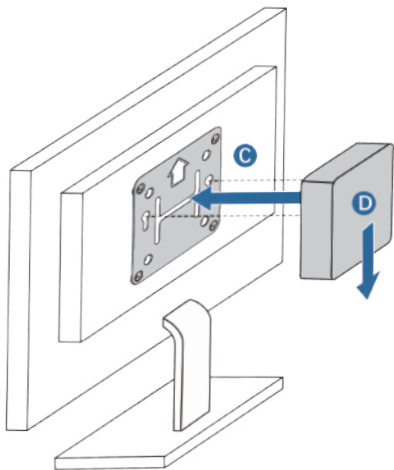













6









## Safety and Caution Information

-  **AC Power Adapter:** Risk of electric shock, fire, or burn if using an AC adapter other than the one provided with this device. Indoor use only and in dry locations. Device must only be repaired by a professional. Do not open enclosure. The adapter is rated for use between 0 °C and 35 °C (32 °F and 95 °F). Connect only to a properly wired and grounded outlet.
-  Risk of explosion if the battery is replaced with an incorrect type. Batteries should be recycled where possible. Disposal of used batteries must be in accordance with local environmental regulations.
-  Failure to use the included power adapter shall violate regulatory compliance requirements and may expose the user to safety hazards.
-  **Temperature:** This device is intended for use in ambient temperatures between 0 °C and 35 °C (32 °F and 95 °F). Avoid using or storing next to heat sources, in direct sunlight, or outside the intended temperature ranges.
-  **Medical:** This device may interfere with the operation of some pacemakers, hearing aids or other medical devices. To reduce the risk, maintain a separation distance of 20 cm (8 inches) between the device and the medical device. Refer to the medical device for additional information.
-  **Modify:** Modification of the wireless solution, thermal solution, device components or enclosure shall violate regulatory compliance requirements and may induce safety hazards.





## Sicherheits- und Warnhinweise

-  **Netzstromadapter:** Es besteht das Risiko des Stromschlags oder der Brand- oder Verbrennungsgefahr, wenn ein anderer als der im Lieferumfang des Geräts enthaltene Netzstromadapter eingesetzt wird. Nur zum Einsatz in Gebäuden und in trockenen Umgebungen. Das Gerät darf nur von einem befugten Techniker repariert werden. Gehäuse nicht öffnen. Der Adapter ist zur Verwendung bei Temperaturen zwischen 0 °C und 35 °C vorgesehen. Nur an eine ordnungsgemäß verkabelte und geerdete Steckdose anschließen.
  
-  Es besteht ein Explosionsrisiko, wenn der Akku durch einen unsachgemäßen Akkutypen ersetzt wird. Akkus sollten soweit möglich zum Recycling abgegeben werden. Bei der Entsorgung verbrauchter Akkus sind alle geltenden örtlichen Umweltschutzvorschriften zu beachten.
  
-  Die Nichtverwendung des im Lieferumfang enthaltenen Netzstromadapters gilt als Verstoß gegen behördliche Compliance-Vorschriften und kann eine Gefährdung des Anwenders darstellen.
  
-  **Temperatur:** Dieses Gerät ist zur Verwendung bei Umgebungstemperaturen zwischen 0 °C und 35 °C vorgesehen. Vermeiden Sie die Verwendung oder Lagerung in der Nähe von Heizquellen, in direkter Sonnenbestrahlung oder in Umgebungen mit Temperaturen außerhalb der vorgesehenen Werte.
  
-  **Medizinisch:** Das Gerät kann Interferenzen im Betrieb von bestimmten Herzschrittmachern, Hörgeräten oder anderen medizinischen Geräten verursachen. Zur Risikominderung sollte ein Abstand von 20 cm zwischen dem Gerät und dem medizinischen Gerät eingehalten werden. Weitere Informationen können Sie den Anleitungen zum medizinischen Gerät entnehmen.
  
-  **Änderungen:** Eine Änderung der Wireless-Lösung, der Kühllösung, der Gerätekomponenten oder des Gehäuses verstößt gegen die Compliance-Vorschriften und kann zu Gefährdungen führen.

## Säkerhets- och försiktighetsinformation

-  **Nätadapter:** Risk för elchock, brand eller brännskada vid användning av annan nätadapter än den som tillhandahålls med denna enhet. Endast inomhusanvändning och på torra platser. Enheten får endast repareras av yrkesman. Öppna inte höljet. Adaptern är märkt för användning mellan 0 °C och 35 °C (32 °F och 95 °F). Anslut endast till jordat vägguttag med korrekt ledningsdragnig.
-  Risk för explosion om batteriet byts ut mot fel typ. Batterier ska återvinnas där så är möjligt. Avyttring av batterier måste ske i enlighet med lokala miljöförordningar.
-  Underlåtande att använda den medföljande nätadaptern innebär överträdelser av krav på efterlevnad och kan föranleda säkerhetsrisker.
-  **Temperatur:** Denna enhet är avsedd för användning i omgivningstemperatur mellan 0 °C och 35 °C (32 °F och 95 °F). Undvik användning eller förvaring i närheten av värmekällor, i direkt solljus eller utanför avsett temperaturintervall.
-  **Medicinskt:** Denna enhet kan orsaka störning i driften av vissa pacemakrar, hörapparater och andra medicinska anordningar. Minska risken genom att upprätthålla ett separationsavstånd på 20 cm (8 tum) mellan enheten och den medicinska anordningen. Hänvisa till den medicinska anordningen för ytterligare information.
-  **Modifera:** Modifiering av den trådlösa lösningen, termal lösning, enhetskomponenter eller hölje kan innebära överträdelser av krav på överensstämmelse och föranleda säkerhetsrisker.

## Informatie over veiligheid en waarschuwingen

-  **AC-adapter:** er bestaat een risico op een elektrische schok, brand of brandwonden als een andere AC-adapter wordt gebruikt dan de adapter die is geleverd bij dit apparaat. Adapter is alleen bedoeld voor gebruik binnenshuis en op droge locaties. Apparaat mag alleen worden gerepareerd door een professional. Open de behuizing niet. De adapter is geschikt voor gebruik bij temperaturen tussen 0 °C en 35 °C. Sluit de adapter aan op een correct bekabeld en geaard stopcontact.
-  Er bestaat een risico op ontploffing indien de batterij wordt vervangen door een onjuist type. Recycle de batterijen indien mogelijk. Het wegwerpen van gebruikte batterijen moet gebeuren in overeenstemming met lokale milieuwetgeving.
-  Het gebruik van een andere adapter dan de inbegrepen voedingsadapter zal tot het overtreden van wettelijke conformiteitseisen leiden en kan ook tot een gevaarlijke situatie voor de gebruiker leiden.
-  **Temperatuur:** dit apparaat is geschikt voor gebruik bij temperaturen tussen 0 °C en 35 °C. Vermijd gebruik of opslag dicht bij warmtebronnen, in direct zonlicht of buiten de geschikte temperatuurbereiken.
-  **Medisch:** dit apparaat kan interfereren met de werking van sommige pacemakers, hoorapparaten of andere medische apparaten. Zorg dat er altijd een afstand van 20 cm is tussen het apparaat en het medische apparaat om het risico te verminderen. Raadpleeg de documentatie bij het medische apparaat voor meer informatie.
-  **Aanpassingen:** aanpassingen aan de draadloze oplossing, componenten van het apparaat of de behuizing kunnen leiden tot schending van de wettelijke conformiteitseisen en kunnen gevaar veroorzaken.

## Información sobre seguridad y precauciones



**Adaptador de corriente CA:** Existe riesgo de choque eléctrico, incendio o quemaduras si se utiliza un adaptador CA que no sea el suministrado con este dispositivo. Use en interiores y lugares secos solamente. El dispositivo sólo puede ser reparado por un profesional. No abra la carcasa. El adaptador está certificado para uso entre 0 °C y 35 °C (32 °F y 95 °F). Conéctelo solamente a un tomacorriente debidamente cableado y con descarga a tierra.



Existe el riesgo de explosión si la batería se reemplaza con una incorrecta. Las baterías deben reciclarse, cuando sea posible. Debe desechar las baterías usadas según las regulaciones locales para proteger el medio ambiente.



No utilizar el adaptador de corriente incluido representa una violación de los requisitos de conformidad regulatoria y podría exponer al usuario a riesgos de seguridad.



**Temperatura:** Este dispositivo está destinado a usarse en temperaturas ambiente de entre 0 °C y 35 °C (32 °F y 95 °F). Evite usar o guardar el dispositivo junto a fuentes de calor, a la luz directa del sol o fuera de los rangos de temperatura indicados.









**Uso médico:** Este dispositivo puede interferir con el funcionamiento de algunos marcapasos, audífonos u otros dispositivos médicos. Para reducir el riesgo, mantenga una distancia de separación de 20 cm (8 pulgadas) entre el dispositivo y el dispositivo médico. Consulte la información del dispositivo médico para obtener más detalles.



**Modificación:** La modificación de la solución inalámbrica, la solución térmica, los componentes del dispositivo o la caja constituyen una violación de los requisitos de conformidad y podrían generar riesgos de seguridad.

## Information sur la sécurité et consignes de prudence

-  **Bloc d'alimentation secteur** : toute utilisation d'un bloc d'alimentation secteur autre que celui qui est fourni avec l'appareil risque de provoquer des chocs électriques, incendies ou brûlures. N'utilisez qu'à l'intérieur et dans des endroits secs. L'appareil doit être réparé exclusivement par un professionnel. N'ouvrez pas le boîtier. Le bloc d'alimentation doit être utilisé entre 0 °C et 35 °C (32 °F et 95 °F). Branchez-le uniquement à une prise correctement câblée et mise à la terre.
-  Risque d'explosion si la batterie est remplacée par une batterie de type incorrect. Les batteries doivent être recyclées dans la mesure du possible. La mise au rebut des batteries usagées doit être réalisée conformément aux réglementations environnementales.
-  Tout manquement à l'utilisation de l'adaptateur secteur inclus constituera une violation des exigences de conformité à la réglementation et peut mettre en danger l'utilisateur.
-  **Température** : cet appareil est prévu pour être utilisé à une température ambiante située entre 0 °C et 35 °C (-32 °F et 95 °F). Évitez de l'utiliser ou de l'entreposer à proximité de sources de chaleur, à la lumière directe du soleil ou hors de la plage de températures prévue.
-  **Appareils médicaux** : il est possible que cet appareil affecte le fonctionnement de certains stimulateurs cardiaques, appareils auditifs ou autres instruments médicaux. Pour réduire les risques, maintenez une distance de séparation de 20 cm (8 pouces) entre l'appareil et l'appareil médical. Reportez-vous à la documentation de l'instrument médical pour davantage d'informations.
-  **Modification** : toute modification de la solution sans fil, de la solution thermique, des composants de l'appareil ou du boîtier constitue une violation des exigences de conformité à la réglementation et peut présenter des risques d'accident.

## Informazioni di avvertenza e sulla sicurezza



**Adattatore di alimentazione CA:** se si usa un adattatore CA diverso da quello fornito con il dispositivo, si corre il rischio di causare scosse elettriche, incendi o ustioni. Utilizzare esclusivamente in ambienti interni e asciutti. Il dispositivo deve essere riparato solo da professionisti. Non aprire l'enclosure. L'adattatore è classificato per l'uso con temperature comprese tra 0 °C e 35 °C. Collegarlo solo a una presa che sia correttamente collegata e dotata di messa a terra.



Se la batteria è sostituita con una di tipo non corretto si corre il rischio di causare un'esplosione. Le batterie devono essere riciclate, se possibile. Lo smaltimento delle batterie usate deve essere effettuato conformemente alla normativa ambientale locale.



Il mancato uso dell'adattatore di alimentazione incluso costituisce una violazione dei requisiti di conformità legali e può esporre l'utente a pericoli per la sicurezza.



**Temperatura:** questo dispositivo è destinato all'uso con temperatura ambiente compresa tra 0 °C e 35 °C. Evitare di utilizzare o conservare il dispositivo accanto a fonti di calore, sotto la luce diretta del sole o in ambienti con temperature esterne all'intervallo delle temperature previste.



**Settore medico:** questo dispositivo può interferire con il funzionamento di alcuni pacemaker, apparecchi acustici o altri dispositivi medici. Per ridurre il rischio, mantenere il dispositivo a una distanza di 20 cm dal dispositivo medico. Per ulteriori informazioni fare riferimento al dispositivo medico.



**Modifica:** la modifica della soluzione wireless, della soluzione termica, dei componenti o dell'enclosure del dispositivo causa la violazione dei requisiti di conformità con le normative e potrebbe creare pericoli per la sicurezza.

## Информация о безопасности и предостережения



Адаптер питания переменного тока: Опасность поражения электрическим током, пожара или ожога при использовании адаптера переменного тока, отличного от прилагаемого к устройству. Использовать только внутри помещений и в сухих местах. Ремонт устройства должен выполняться только профессионалом. Не открывайте корпус. Адаптер рассчитан на использование при температуре от 0 °C до 35 °C (32 °F - 95 °F). Подключайте только к правильно подключенной и заземленной розетке.



Опасность взрыва при замене батареи на батарею неправильного типа. Батареи должны быть переработаны, если это возможно. Утилизация использованных батарей должна производиться в соответствии с местными нормами охраны окружающей среды.



Неиспользование прилагаемого адаптера питания нарушает нормативные требования и может подвергнуть пользователя опасности.



Температура: Данное устройство предназначено для использования при температуре окружающей среды от 0 °C до 35 °C (32 °F - 95 °F). Избегайте использования или хранения рядом с источниками тепла, под прямыми солнечными лучами или вне предусмотренных температурных диапазонов.



Медицина: Это устройство может мешать работе некоторых кардиостимуляторов, слуховых аппаратов или других медицинских приборов. Для снижения риска соблюдайте расстояние 20 см (8 дюймов) между устройством и медицинским прибором. Дополнительную информацию см. на медицинском приборе.



Внесение изменений: Модификация беспроводного решения, теплового решения, компонентов устройства или корпуса нарушает нормативные требования и может привести к возникновению угрозы безопасности.

## 安全と注意



【AC電源アダプタ】付属のACアダプタ以外を使用すると、感電や火災、火傷の危険があります。屋内の乾燥した場所で使用してください。修理は必ず専門業者に任せてください。解体しないでください。このアダプタは0~35℃(32°F~95°F)での使用を想定した設計になっています。正しく配線、アースされたコンセントのみに接続してください。



誤った種類の電池を入れると、爆発する恐れがあります。電池は可能な限りリサイクルしてください。使用済みの電池を廃棄する際は、地域の環境規制に従ってください。



付属の電源アダプタを使用しないことは規制違反であり、利用者を危険にさらす可能性があります。



【温度】このデバイスは、0~35℃(35~95°F)の室温で使用することを想定した設計になっています。熱源の近くや直射日光、または想定温度範囲外での使用や保管は避けてください。



【医療】このデバイスは、一部のペースメーカーや補聴器、その他の医療機器に影響を及ぼすことがあります。そのリスクを減らすため、本機と医療機器の間に20cmの距離を確保してください。さらに詳しい情報については、医療機器をご確認ください。



【変更】ワイヤレス、サーマル、デバイス部品等の改造は、規制違反に当たり、危険につながる可能性があります。

## 안전 경고 메시지



교류 전원 어댑터: 장비와 함께 제공되지 않는 교류 전원 어댑터를 사용하면 감전, 화재 또는 화상의 위험이 있습니다. 실내 및 건조한 환경에만 적용합니다. 전문 인력에 한하여 장비를 수리할 수 있습니다. 케이스를 열지 마십시오. 어댑터의 정격 온도는 0°C 부터 35°C(32°F 부터 95°F) 사이입니다. 정확한 연결과 접지된 전원 콘센트에만 연결 가능합니다.



배터리를 부당하게 교체하면 폭발 위험이 있습니다. 가능한 배터리를 재활용하십시오. 폐배터리의 처리는 반드시 현지 환경 법규에 부합해야 합니다.



첨부된 전원 어댑터를 사용하지 않으면 규정 준수 요구를 위반할 수 있으며 사용자에게 안전 위험을 초래할 수 있습니다.



온도: 본 장비는 0°C 부터 35°C(32°F 부터 95°F)의 환경 온도에서 사용하기에 적합합니다. 열원 근처, 직사광선 속, 또는 지정된 온도 범위를 초과하여 사용하거나 보관하지 마십시오.



의료: 본 장비는 일부 심박조율기, 보청기 또는 기타 의료 장비의 작동을 방해할 수 있습니다. 이러한 위험을 피하기 위해 본 장비와 의료 장비 사이의 거리를 20cm (8인치)로 유지하십시오. 자세한 정보는 의료장비의 설명서를 참조하십시오.



수정: 무선 솔루션, 방열 방안, 장비 구성 요소 또는 케이스를 수정하면 규정 준수 요구를 위반하기에 안전 위험을 초래할 수 있습니다.

## 安全警告信息



**交流电源适配器:**使用非随设备提供的交流电源适配器会有触电、火灾或灼伤的风险。仅适用于室内和干燥的环境。仅限专业人员修理设备。不要打开外壳。适配器的额定温度为0°C到35°C (32°F到95°F) 之间。仅连接到正确连线和接地的电源插座。



如果电池更换不当, 会有爆炸的危险。尽可能回收电池。废旧电池的处理必须符合当地环境法规。



不使用附带的电源适配器会违反合规要求, 并可能使用户面临安全风险。



**温度:**此设备适合在0°C到35°C (32°F到95°F) 的环境温度中使用。避免在热源附近、阳光直射下或在指定温度范围之外使用或存储。



**医疗:**此设备可能会对某些起搏器、助听器或其他医疗设备操作造成干扰。为降低此风险, 请在此设备和医疗设备之间保持20厘米(8英寸) 的间隔距离。请参阅医疗设备的说明以了解更多信息。



**修改:**对无线解决方案、散热方案、设备组件或外壳进行修改会违反合规要求, 并导致安全风险。

## Informasi peringatan keamanan



Adaptor Daya AC: Penggunaan adaptor daya AC yang tidak disertakan bersama perangkat dapat menimbulkan risiko sengatan listrik, kebakaran, atau luka bakar. Hanya untuk lingkungan dalam ruangan dan kering. Hanya personel berkualifikasi yang boleh memperbaiki peralatan. Jangan buka casingnya. Adaptor memiliki rating suhu antara 0°C dan 35°C (32°F dan 95°F). Hubungkan hanya ke stopkontak listrik yang berkabel dan diarde dengan benar.



Jika baterai tidak diganti dengan benar, terdapat risiko ledakan. Daur ulang baterai bila memungkinkan. Pembuangan baterai bekas harus mematuhi peraturan lingkungan setempat.



Kegagalan menggunakan adaptor daya yang disertakan melanggar persyaratan kepatuhan dan dapat menimbulkan risiko keamanan bagi pengguna.



Suhu: Perangkat ini cocok untuk digunakan pada suhu sekitar dari 0°C hingga 35°C (32°F hingga 95°F). Hindari penggunaan atau penyimpanan di dekat sumber panas, terkena sinar matahari langsung, atau di luar kisaran suhu yang ditentukan.



Medis: Perangkat ini dapat menyebabkan gangguan pada pengoperasian alat pacu jantung, alat bantu dengar, atau perangkat medis tertentu lainnya. Untuk mengurangi risiko ini, jaga jarak 20 cm (8 inci) antara perangkat ini dan peralatan medis. Lihat petunjuk perangkat medis untuk informasi lebih lanjut.



Modifikasi: Modifikasi pada solusi nirkabel, solusi pendinginan, komponen perangkat, atau penutup dapat melanggar persyaratan kepatuhan dan mengakibatkan risiko keamanan.

## ⚠ WARNING

- **INGESTION HAZARD:** This product contains a button cell or coin battery.
- **DEATH** or serious injury can occur if ingested.
- A swallowed button cell or coin battery can cause **Internal Chemical Burns** in as little as **2 hours**.
- **KEEP new and used batteries OUT OF REACH of CHILDREN**
- **Seek immediate medical attention** if a battery is suspected to be swallowed or inserted inside any part of the body.



- Remove and immediately recycle or dispose of used batteries according to local regulations and keep away from children. Do NOT dispose of batteries in household trash or incinerate.
- Even used batteries may cause severe injury or death.
- Call a local poison control center for treatment information.
- The compatible battery type CR2032.
- The nominal battery voltage 3V.
- Non-rechargeable batteries are not to be recharged.
- Do not force discharge, recharge, disassemble, heat above (manufacturer's specified temperature rating) or incinerate. Doing so may result in injury due to venting, leakage or explosion resulting in chemical burns.

Products with non-replaceable button/coin cell batteries shall additionally include a statement indicating the product contains non-replaceable batteries.

**FCC Caution:**

Any Changes or modifications not expressly approved by the party responsible for compliance could void the user's authority to operate the equipment.

This device complies with part 15 of the FCC Rules. Operation is subject to the following two conditions:

(1) This device may not cause harmful interference, and (2) this device must accept any interference received, including interference that may cause undesired operation.

NOTE: This equipment has been tested and found to comply with the limits for a Class B digital device, pursuant to part 15 of the FCC Rules. These limits are designed to provide reasonable protection against harmful interference in a residential installation. This equipment generates, uses and can radiate radio frequency energy and, if not installed and used in accordance with the instructions, may cause harmful interference to radio communications. However, there is no guarantee that interference will not occur in a particular installation. If this equipment does cause harmful interference to radio or television reception, which can be determined by turning the equipment off and on, the user is encouraged to try to correct the interference by one or more of the following measures:

—Reorient or relocate the receiving antenna.

—Increase the separation between the equipment and receiver.

—Connect the equipment into an outlet on a circuit different from that to which the receiver is connected.

—Consult the dealer or an experienced radio/TV technician for help.

**FCC Radiation Exposure Statement:**

This equipment complies with FCC radiation exposure limits set forth for an uncontrolled environment. This equipment should be installed and operated with minimum distance 20cm between the radiator & your body.

**Connect to a Network:**

1. Click the network icon in the notification area in Windows. A list of available wireless networks will be shown.
2. Select the desired network, input the information (if needed).

Note: when connecting to a secured wireless network, enter your Wi-Fi password when prompted.

**Customer Support:** [support@geekompc.com](mailto:support@geekompc.com)  
[www.geekompc.com](http://www.geekompc.com)